



Odlévaný model / All resin kit

8062
1/48

Zetor 25 'Agricultural version'

Visit our official website and e-shop at

www.cmkkits.com
www.specialhobby.eu

www.facebook.com/specialhobby

PUR - Polyurethane parts

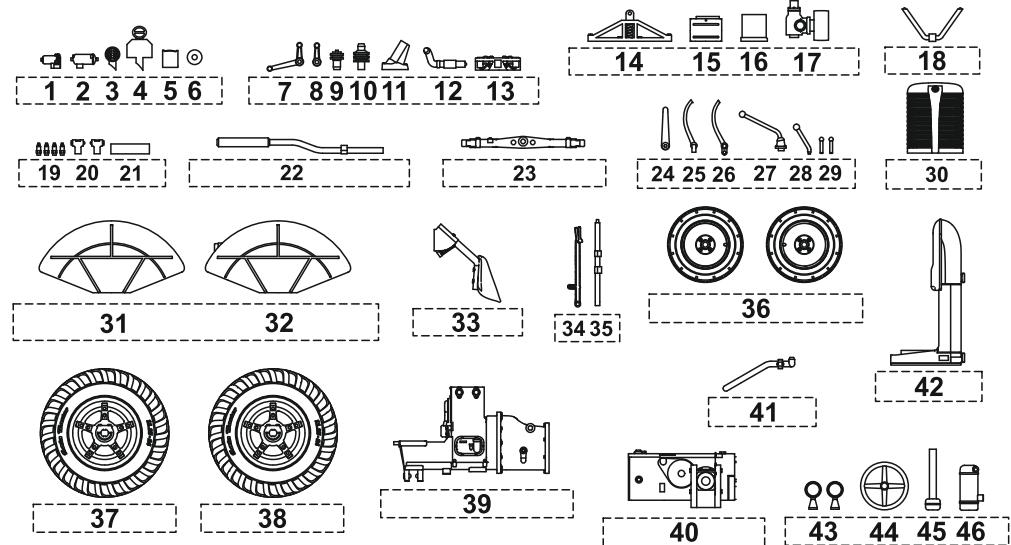

PE - Photo-etched parts

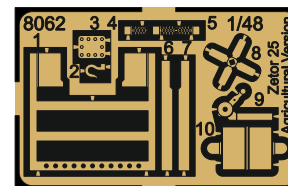

Decals

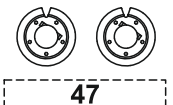
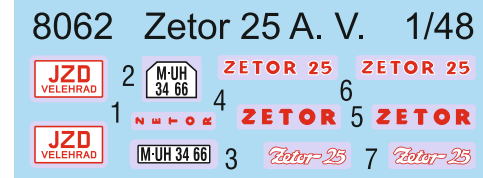

drát není součástí
wire not included

Díly ohnuté popř. pokroucené vlivem teplotních změn a stárnutí materiálu, mohou být narovnané do požadovaného tvaru pomocí proudu teplé vody nebo vzduchu (fén na vlasy). Různé drátky a tyčky nejsou přiloženy. Kontaktní plochy doporučujeme před lepením omastit.

Parts slightly distorted and bent owing to temperature changes or due to material ageing can be straightened to requested shape by hot water or hot air jet (hair dryer). This process can be repeated till result is entirely satisfactory. Wires and rods not included. It is recommended to remove grease from contact areas

K lepení použít kyanoakrylátové lepidlo / For best gluing results use cyanoacrylate glue!

SYMBOLS

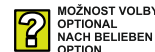

Producer: Special Hobby, Mezilesí 718, 193 00 Praha 9, Czech Republic

obtisk 6
decal 6

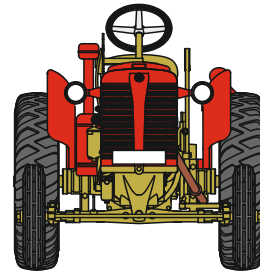
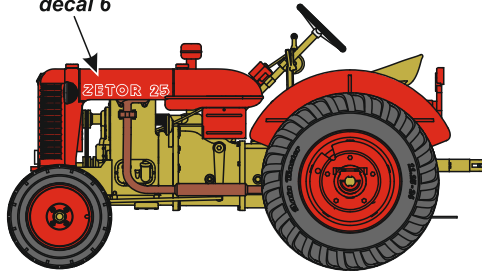

obtisk 6
decal 6

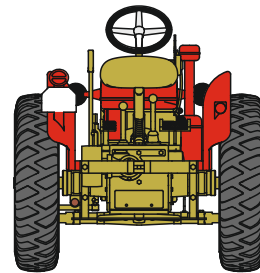
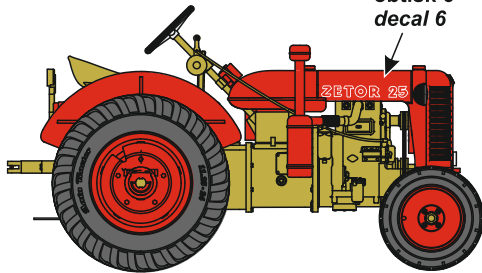

Při použití jiného zbarvení použijte kombinaci obtisků.
Other colour schemes can be built using different combinations of decals.

1/48 8060
T34/85 Solid
Track Wheels



1/48 8061
T-34 Makeshift
Wheel (from Panther)



CMK sets for Tamiya kits

8059 1/48
Pz.38(t) Ausf. E/F
resin engine set



Use this!



Star Dust
weathering pigments

